

Distribution Boxes

BXM(D)81 Series Explosion-proof Illumination (Power) Distribution Boxes (Ex d IIB+H2)



- ◆ Explosion protection to
 - CENELEC
 - IEC
 - NEC
- ◆ Can be used in
 - Zone 1 and Zone 2
 - Zone 21 and Zone 22
 - Class I, Zone 1 and Zone 2
 - Class I, Division 1, Groups C, D
- ◆ Flameproof enclosure (Ex d IIB)
- ◆ Main switch and branch switch are operated with external rotary actuator.
- ◆ Internal wiring to the terminal is finished.
- ◆ International brand of terminal blocks.
- ◆ Copper-free Aluminium Alloy (carbon steel), powder coated surface, or stainless steel.
- ◆ Entries plugged. Cable glands on request (see P7/20~31).
- ◆ Special requirements on request.

■ Catalogue number logic

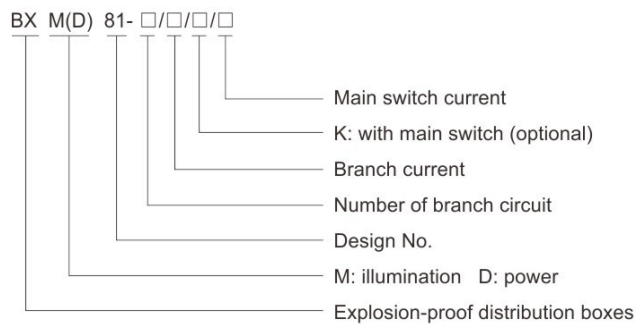

Zones 1&2; 21&22

Distribution Boxes

BXM81 Series Explosion-proof Illumination Distribution Boxes (Ex d IIB+H2)

Technical data	
Explosion-proof illumination distribution boxes	BXM81-□/□/□/□
Explosion protection	
Global (IECEX)	IECEX CQM 11.0032X
Gas and dust	Ex db IIB+H ₂ T6 Gb Ex tb IIIC T80°C Db IP66
Europe (ATEX)	LCIE 11 ATEX 3064X
Gas and dust	⊕ II 2 G Ex db IIB+H ₂ T6 Gb ⊕ II 2 D Ex tb IIIC T80°C Db IP66
Certificates	IECEX; ATEX; CU-TR
Conformity to standards	EN 60079-0, EN 60079-1, EN 60079-31 IEC 60079-0, IEC 60079-1, IEC 60079-31
General power supply	Rated voltage: max. 690V AC 50/60Hz; Rated current: max. 100A
Branch current	1A, 2A, 4A, 6A, 10A, 16A, 20A, 25A, 32A
Exposed fastener	Stainless steel
Enclosure material	Copper-free Aluminium Alloy (carbon steel), powder coated surface, or stainless steel
Enclosure colour	Window grey (RAL7040)
Built-in components	
Main switch	MCB (miniature circuit breaker) or MCCB (moulded case circuit breaker) Note: earth leakage protection on request
Branch switch	MCB (miniature circuit breaker) or MCCB (moulded case circuit breaker) Note: earth leakage protection on request
Terminal	International brand of terminal blocks
Indicator	Red, green, yellow
Degree of protection	IP66, IP67 (optional)
Internal & external earthing	M6/M8, M8/M8
Ambient temperature	-60°C~+55°C
Cable entries	Standard M□ x 1.5 plug (see the Selection table on P6/16)
Cable gland (optional)	DQM-II (Ex d) or DQM-III (Ex d) is recommended. Please see P7/20~31
Entry direction	Bottom
Mounting	Surface type (standard) Pedestal type (optional)



Electrical schematic diagram

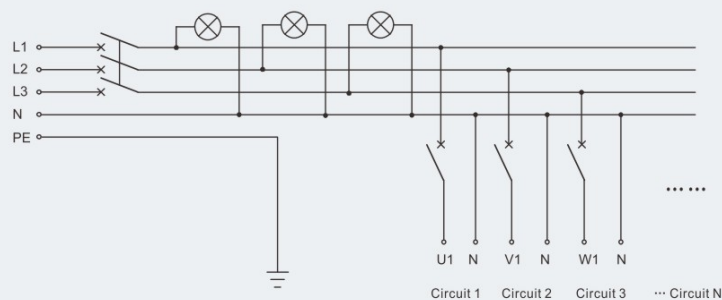

BXM81 Series explosion-proof illumination distribution boxes

Distribution Boxes

BXM81 Series Explosion-proof Illumination Distribution Boxes (Ex d IIB+H2)

Selection table of BXM81 series explosion-proof illumination distribution boxes

Version	Description					Cable entries
	Main switch	Number of branch circuit	Branch switch	Branch current	Number of indicator	
BXM81-4/□/K/□	MCB or MCCB	4	MCB 1P/2P	1A 2A 4A 6A 10A 16A 20A 25A 32A On request	3	1 x M32 x 1.5 + 4 x M25 x 1.5
BXM81-6/□/K/□		6			3	1 x M40 x 1.5 + 6 x M25 x 1.5
BXM81-8/□/K/□		8			3	1 x M40 x 1.5 + 8 x M25 x 1.5
BXM81-10/□/K/□		10			3	1 x M40 x 1.5 + 10 x M25 x 1.5
BXM81-12/□/K/□		12			3	1 x M40 x 1.5 + 12 x M25 x 1.5
BXM81-4/□	—	4	MCB 1P/2P	1A 2A 4A 6A 10A 16A 20A 25A 32A On request	3	1 x M40 x 1.5 + 4 x M25 x 1.5
BXM81-6/□		6			3	1 x M40 x 1.5 + 6 x M25 x 1.5
BXM81-8/□		8			3	1 x M40 x 1.5 + 8 x M25 x 1.5
BXM81-10/□		10			3	1 x M40x 1.5 + 10 x M25 x 1.5
BXM81-12/□		12			3	1 x M40 x 1.5 + 12 x M25 x 1.5

Note

1. Please specify the number and size of cable entries and sides of the enclosure to be fitted.
2. Electrical schematic diagram shall be provided by user. Photo switch, AC contactor, thermal relay or others on request.
3. Please specify mounting type when ordering.
4. Rainproof canopy on request.



Distribution Boxes

BXD81 Series Explosion-proof Power Distribution Boxes (Ex d IIB+H₂)

Technical data	
Explosion-proof power distribution boxes BXD81-□/□/□/□	
Explosion protection	
Global (IECEX)	IECEX CQM 11.0032X
Gas and dust	Ex db IIB+H ₂ T6 Gb Ex tb IIIC T80°C Db IP66
Europe (ATEX)	LCIE 11 ATEX 3064X
Gas and dust	⊕ II 2 G Ex db IIB+H ₂ T6 Gb ⊕ II 2 D Ex tb IIIC T80°C Db IP66
Certificates	IECEX; ATEX; CU-TR
Conformity to standards	EN 60079-0, EN 60079-1, EN 60079-31 IEC 60079-0, IEC 60079-1, IEC 60079-31
General power supply	Rated voltage: max. 690V AC 50/60Hz; Rated current: max. 630A
Branch current	1A, 2A, 4A, 6A, 10A, 16A, 20A, 25A, 32A, 40A, 50A, 63A 80A, 100A, 125A, 160A, 200A, 250A, 320A, 400A
Exposed fastener	Stainless steel
Enclosure material	Copper-free Aluminium Alloy (carbon steel), powder coated surface, or stainless steel
Enclosure colour	Window grey (RAL7040)
Built-in components	
Main switch	MCB (miniature circuit breaker) or MCCB (moulded case circuit breaker) Note: earth leakage protection on request
Branch switch	MCB (miniature circuit breaker) or MCCB (moulded case circuit breaker) Note: earth leakage protection on request
Terminal	International brand of terminal blocks
Indicator	Red, green, yellow
Degree of protection	IP66, IP67 (optional)
Internal&external earthing	M6/M8, M8/M8
Ambient temperature	-60°C~+55°C
Cable entries	Standard M□ x 1.5 plug (see the Selection table on P6/18)
Cable gland (optional)	DQM-II (Ex d) or DQM-III (Ex d) is recommended. Please see P7/20~31
Entry direction	Bottom
Mounting	Surface type (standard) Pedestal type (optional)



Electrical schematic diagram

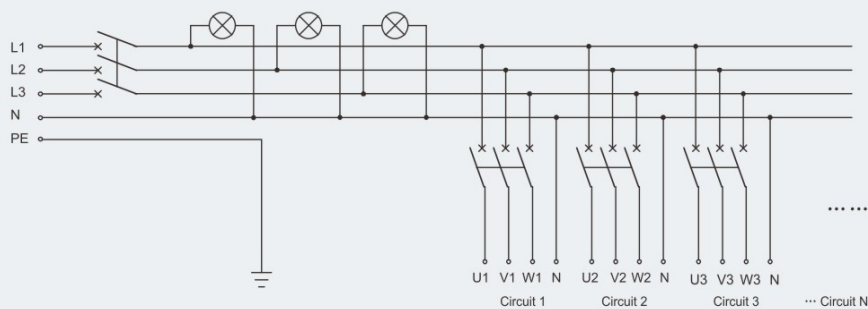

BXD81 Series explosion-proof power distribution boxes

Distribution Boxes

BXD81 Series Explosion-proof Power Distribution Boxes (Ex d IIB+H2)

Selection table of BXD81 series explosion-proof power distribution boxes

Version	Description					Cable entries
	Main switch	Number of branch circuit	Branch switch	Branch current	Number of indicator	
BXD81-4/□/□/□	MCB or MCCB Current: max. 630A	4	MCB or MCCB 3P	1A, 2A 4A, 6A 10A, 16A 20A, 25A 32A, 40A 50A, 63A 80A, 100A 125A, 160A 200A, 250A 320A, 400A On request	3	1 x M50(M63, M75, M90) x 1.5 + 4 x M25(M32, M40, M50, M63) x 1.5
BXD81-6/□/□/□		6			3	1 x M50(M63, M75, M90) x 1.5 + 6 x M25(M32, M40, M50, M63) x 1.5
BXD81-8/□/□/□		8			3	1 x M50(M63, M75, M90) x 1.5 + 8 x M25(M32, M40, M50, M63) x 1.5
BXD81-10/□/□/□		10			3	1 x M50(M63, M75, M90) x 1.5 + 10 x M25(M32, M40, M50, M63) x 1.5
BXD81-12/□/□/□		12			3	1 x M50(M63, M75, M90) x 1.5 + 12 x M25 x 1.5
BXD81-4/□	—	4	MCB or MCCB 3P	1A, 2A 4A, 6A 10A, 16A 20A, 25A 32A, 40A 50A, 63A 80A, 100A 125A, 160A 200A, 250A 320A, 400A On request	3	1 x M50(M63, M75, M90) x 1.5 + 4 x M25(M32, M40, M50, M63) x 1.5
BXD81-6/□		6			3	1 x M50(M63, M75, M90) x 1.5 + 6 x M25(M32, M40, M50, M63) x 1.5
BXD81-8/□		8			3	1 x M50(M63, M75, M90) x 1.5 + 8 x M25(M32, M40, M50, M63) x 1.5
BXD81-10/□		10			3	1 x M50(M63, M75, M90) x 1.5 + 10 x M25(M32, M40, M50, M63) x 1.5
BXD81-12/□		12			3	1 x M50(M63, M75, M90) x 1.5 + 12 x M25(M32, M40, M50, M63) x 1.5

Note

1. Please specify the number and size of cable entries and sides of the enclosure to be fitted.
2. Electrical schematic diagram shall be provided by user. Photo switch, AC contactor, thermal relay or others on request.
3. Please specify mounting type when ordering.
4. Rainproof canopy on request.



Distribution Boxes

BXM81 Series Explosion-proof Illumination Distribution Boxes (Ex d IIB+H2)

Dimension drawings (all dimensions in mm) - subject to alteration

Note: The following drawings are suitable for copper-free aluminium products

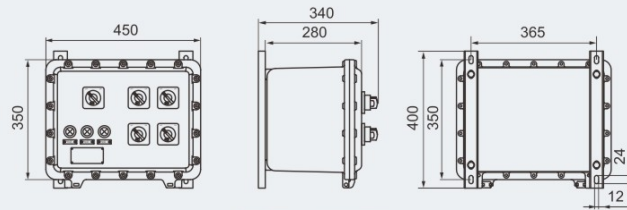

BXM81-4/□/□/□

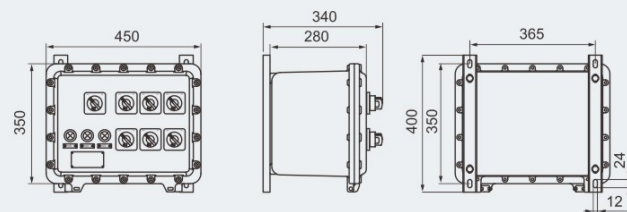

BXM81-6/□/□/□

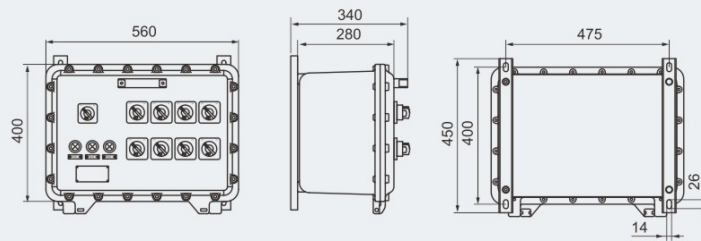

BXM81-8/□/□/□

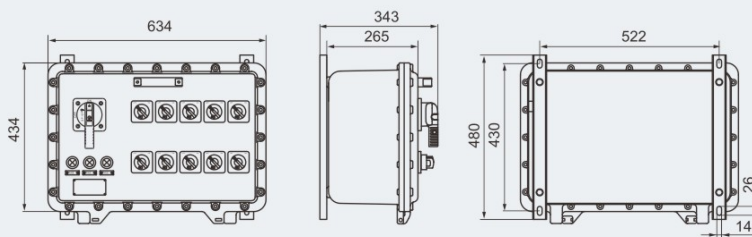

BXM81-10/□/□/□

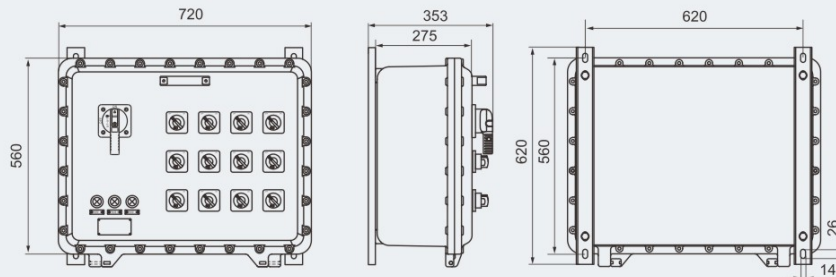

BXM81-12/□/□/□



Distribution Boxes

BXD81 Series Explosion-proof Power Distribution Boxes (Ex d IIB+H2)

Dimension drawings (all dimensions in mm) - subject to alteration

Note: The following drawings are suitable for copper-free aluminium products

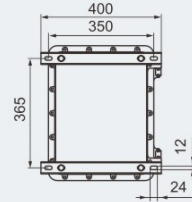
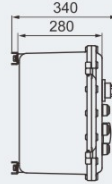
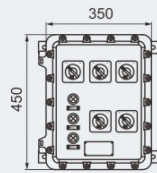

BXD81-4/□/□/□

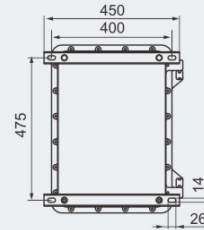
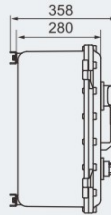
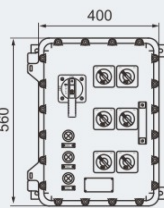

BXD81-6/□/□/□

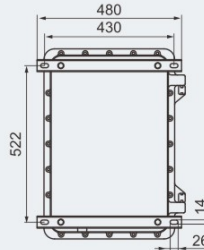
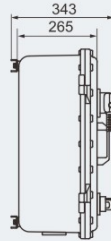
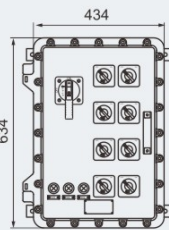

BXD81-8/□/□/□

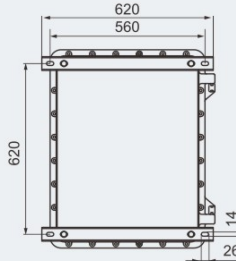
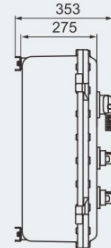
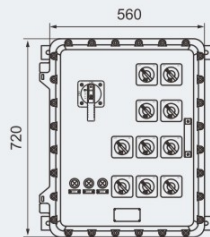

BXD81-10/□/□/□

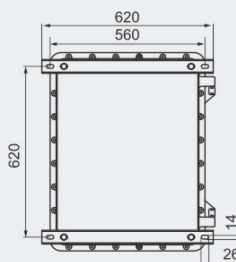
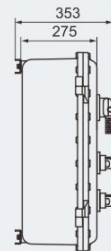
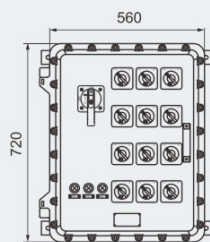

BXD81-12/□/□/□



Distribution Boxes

BXM(D)81 Series Explosion-proof Illumination (Power) Distribution Boxes (Ex d IIB+H2)

Dimension drawings (all dimensions in mm) - subject to alteration

Note: The following drawings are suitable for carbon steel or stainless steel products

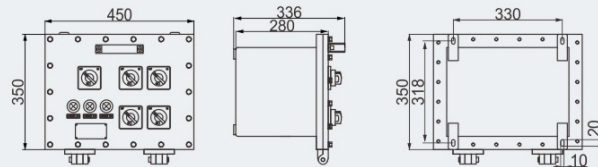

BXM(D)81-4/□/□/□

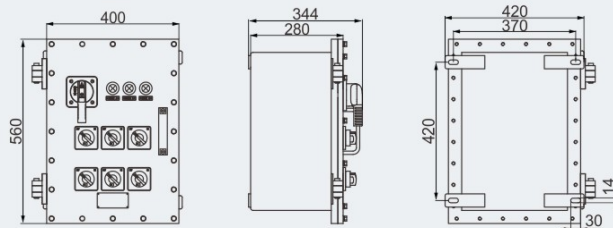

BXM(D)81-6/□/□/□

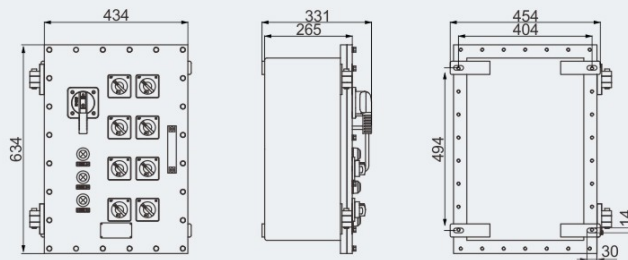

BXM(D)81-8/□/□/□

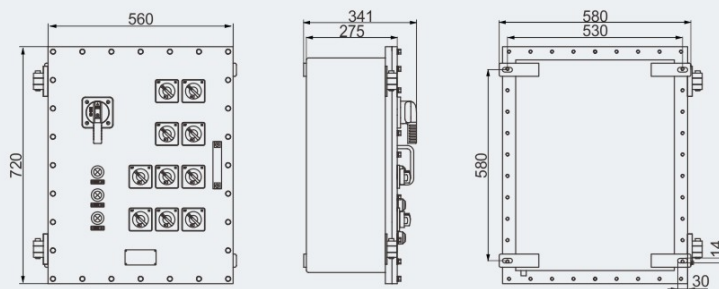

BXM(D)81-10/□/□/□

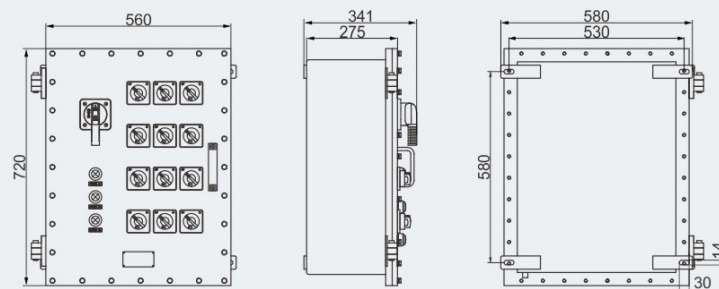

BXM(D)81-12/□/□/□

